

This light head EMALED 560 is optically identical with the EMALED 500 light head, but grants the highest possible illumination (160.000lx) and can therefore satisfy even the highest requirements.

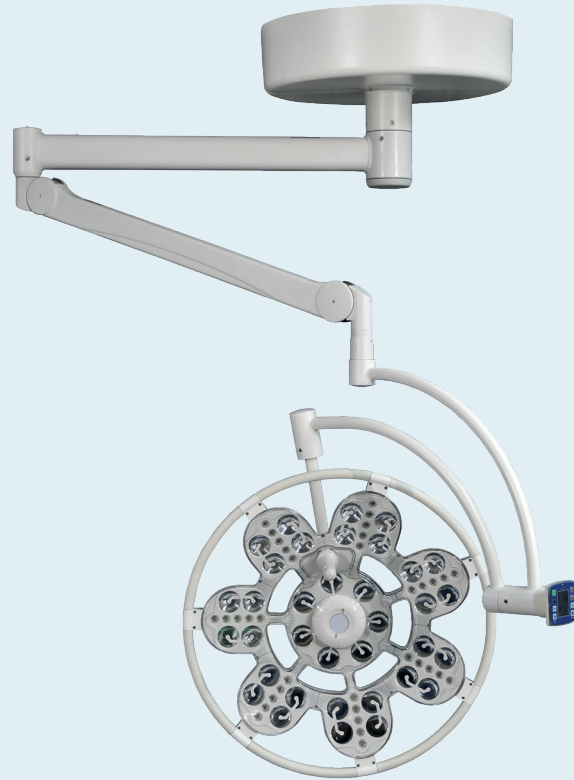
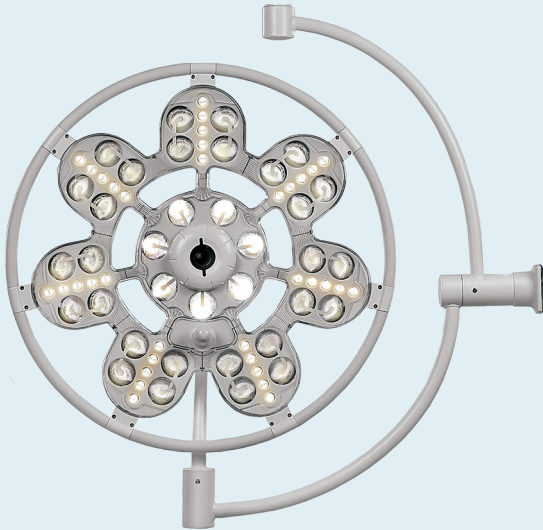

TECHNICAL DETAILS

Illumination (at 1 m)	160.000 lx
Lighting intensity	10 - 100 %
Focusable diameter of lightning field D10	185 - 350 mm
Operating distance	70 - 140 cm
Colour temperature	4.500 K
Colour rendering index	96 Ra
Life expectancy of LED´s	50.000 hrs
Diameter of light head	650 mm
Number of LEDs	70
Main voltage	100 - 240 V / 24 V
Frequency	50 - 60 Hz
Power consumption	60 VA
Weight of lighting element	9,5 kg
Weight of complete system	80 kg

- Natural colour rendering grants a great light quality
- Shadow-free illumination
- Barely noticeable heating of the light head
- No movable parts in the light head
- Low maintenance requirements
- Adjustable illumination in 10 steps
- Powder coated aluminium case
- Two autoclavable handles are included (additional handles can be ordered any time)
- High flexibility: 360° rotation horizontal
- 4-step focusing via the control panel with LCD display
- Endoscopic mode
- Macro mode

Optional available:

- Remote control (also for double dome lights)
- Emergency power back-up (for up to 4hrs network independent use)
- Full HD camera
- Laser pointer
- Variable colour temperature: 3500 - 5000 K (5-steps)

